



EMERSON[™]
Industrial Automation



4250 en - 2010.10 / b



PARTNER ALTERNATOR

LSA 40 - 4 POLE - 10 à 25 KVA - 400V

Technical data sheet

SPECIALY ADAPTED TO APPLICATIONS

The LSA 40 alternator is designed to be suitable for typical generator applications, such as: backup, marine applications, rental, telecommunications, etc.

COMPLIANT WITH INTERNATIONAL STANDARDS

The LSA 40 alternator conforms to the main international standards and regulations:

- IEC 60034, NEMA MG 1.22, ISO 8528/3, CSA, UL 1446, UL 1004B on request, marine regulations, etc.

It can be integrated into a CE marked generator.

The LSA 40 is designed, manufactured and marketed in an ISO 9001 environment.

TOP OF THE RANGE ELECTRICAL PERFORMANCE

- Class H insulation.
- Standard 12 wire re-connectable winding, 2/3 pitch, type no. 6.
- Voltage range:
 - 50 Hz: 220 V - 240 V and 380 V - 415 V (440 V)
 - 60 Hz: 208 V - 240 V and 380 V - 480 V
- High efficiency and motor starting capacity.
- Other voltages are possible with optional adapted windings:
 - 50 Hz: 440 V (no. 7), 500 V (no. 9), 690 V (no. 10 or 52)
 - 60 Hz: 380 V and 416 V (no. 8), 600 V (no. 9)
- Total harmonic distortion < 2% (full load).
- R 791 interference suppression conforming to standard EN 55011 group 1 class B standard for European zone (CE marking).

EXCITATION AND REGULATION SYSTEM SUITED TO THE APPLICATION

Excitation system			Regulation options		
Voltage regulator (AVR)	SHUNT	AREP	C.T. Current transformer for connecting modules in parallel	R 731 3-phase sensing	P Remote voltage potentiometer
R 220	Std	-	-	-	-
R 438		Std	√	√	√

AVR voltage accuracy $\pm 0.5\%$.

√: possible adaptation.

PROTECTION SYSTEM SUITED TO THE ENVIRONMENT

- The LSA 40 is IP 23.
 - Standard winding protection for clean environments with relative humidity $\leq 95\%$, including indoor marine environments.
- Options:
- Filters on air inlet and air outlet (IP 44).
 - Winding protection for harsh environments and relative humidity greater than 95%.
 - Space heaters.
 - Thermal protection for stator windings.

REINFORCED MECHANICAL STRUCTURE USING FINITE ELEMENT MODELLING

- Compact rigid assembly to better withstand generator vibrations.
- Steel frame.
- Aluminium flanges and shields.
- Two-bearing and single-bearing versions designed to be suitable for commercially-available heat engines.
- Half-key balancing.
- Permanently greased bearings.
- Direction of rotation :
 - for single bearing, clockwise only when looking at the drive end view, (anti-clockwise with derating, consult factory),
 - for two bearing, both clockwise and anti-clockwise when looking at the drive end view (without derating).

ACCESSIBLE TERMINAL BOX

- Easy access to the AVR and to the connections.
- 8 way terminal block for reconnecting the voltage.
- Predrilled holes for cable gland.

Copyright 2004: MOTEURS LEROY-SOMER

LEROY-SOMER reserves the right to modify the design, technical specifications and dimensions of the products shown in this document. The descriptions cannot in any way be considered contractual. The values indicated are typical values.

General characteristics

Insulation class	H	Excitation system	SHUNT	AREP
Winding pitch	2/3 (wdg 6)	AVR type	R 220	R 438
Number of wires	12	Voltage regulation (*)	± 0.5%	± 0.5%
Protection	IP 23	Short-circuit current	-	300% (3 IN): 10 s
Altitude	≤ 1000 m	Harmonic distortion (* *) TGH/THC	no load < 3% - on load < 2%	
Overspeed	2250 min ⁻¹	Waveform: NEMA = TIF - (* *)	< 50	
Air flow	0.06 m ³ /s, 50 Hz - 0.072 m ³ /s, 60 Hz	Waveform: IEC = FHT - (* *)	< 2%	

(*) Steady state. (* *) Harmonic distortion between phases, no-load or on-load (non-distorting).

Ratings 50 Hz - 1500 R.P.M.

kVA / kW - P.F. = 0,8																				
Duty/T°C	Continuous duty/40°C					Continuous duty/40°C					Stand-by/40°C					Stand-by/27°C				
Class/T°C	H/125°K					F/105°K					H/150°K					H/163°K				
Phase	3 ph.			1 ph.		3 ph.			1 ph.		3 ph.			1 ph.		3 ph.			1 ph.	
Y	380V	400V	415V	440V	ΔΔ	380V	400V	415V	440V	ΔΔ	380V	400V	415V	440V	ΔΔ	380V	400V	415V	440V	ΔΔ
Δ	220V	230V	240V	230V		220V	230V	240V	230V		220V	230V	240V	230V		220V	230V	240V	230V	
YY	220V					220V					220V					220V				
40 VS1	10	10	10	9	7	9	9	9	8	6.5	10.5	10.5	10.5	9	7.5	11	11	11	10	8
	8	8	8	7.2	5.6	7.2	7.2	7.2	6.4	5.2	8.4	8.4	8.4	7.2	6	8.8	8.8	8.8	8	6.4
40 VS2	12.5	12.5	12.5	11	9	11.5	11.5	11.5	10	8	13.5	13.5	13.5	12	9.5	14	14	14	12.5	10
	10	10	10	8.8	7.2	9.2	9.2	9.2	8	6.4	10.8	10.8	10.8	9.6	7.6	11.2	11.2	11.2	10	8
40 S3	15	15	15	13	10.5	14	14	14	12	10	16	16	16	14	11.5	16.5	16.5	16.5	15	12
	12	12	12	10.4	8.4	11.2	11.2	11.2	9.6	8	12.8	12.8	12.8	11.2	9.2	13.2	13.2	13.2	12	9.6
40 S4	17.5	17.5	17.5	16	12.5	16	16	16	14	11.5	19	19	19	16.5	13.5	19.5	19.5	19.5	17	14
	14	14	14	12.8	10	12.8	12.8	12.8	11.2	9.2	15.2	15.2	15.2	13.2	10.8	15.6	15.6	15.6	13.6	11.2
40 M5	20	20	20	18	14	18.5	18.5	18.5	16	13	21.5	21.5	21.5	19	15	22	22	22	20	15.5
	16	16	16	14.4	11.2	14.8	14.8	14.8	12.8	10.4	17.2	17.2	17.2	15.2	12	17.6	17.6	17.6	16	12.4
40 L7	23	23	23	19	15	20	20	20	16	14	24	24	24	20	16	25	25	25	22	16.5
	18.4	18.4	18.4	15.2	12	16	16	16	12.8	11.2	19.2	19.2	19.2	16	12.8	20	20	20	17.6	13.2

Ratings 60 Hz - 1800 R.P.M.

kVA / kW - P.F. = 0,8																				
Duty/T°C	Continuous duty/40°C					Continuous duty/40°C					Stand-by/40°C					Stand-by/27°C				
Class/T°C	H/125°K					F/105°K					H/150°K					H/163°K				
Phase	3 ph.			1 ph.		3 ph.			1 ph.		3 ph.			1 ph.		3 ph.			1 ph.	
Y	380V	416V	440V	480V	ΔΔ	380V	416V	440V	480V	ΔΔ	380V	416V	440V	480V	ΔΔ	380V	416V	440V	480V	ΔΔ
Δ	220V	240V		240V		220V	240V		240V		220V	240V		240V		220V	240V		240V	
YY	208V	220V	240V			208V	220V	240V			208V	220V	240V			208V	220V	240V		
40 VS1	10	11	11,5	12,5	9	9,5	10,5	10,5	11,5	8,5	11	11,5	12,5	13,5	9,5	11,5	12	13	14	10
	8,0	8,8	9,2	10,0	7,2	7,6	8,4	8,4	9,2	6,8	8,8	9,2	10	10,8	7,6	9,2	9,6	10,4	11,2	8
40 VS2	12,5	13,5	14,5	15,5	11,5	11,5	12,5	13,5	14,5	10,5	13,5	14,5	15,5	16,5	12	14	15	16	17	12,5
	10,0	10,8	11,6	12,4	9,2	9,2	10	10,8	11,6	8,4	10,8	11,6	12,4	13,2	9,6	11,2	12	12,8	13,6	10
40 S3	15	16,5	17,5	19	13	14	15,5	16,5	17,5	12	16	18	19	20	13,5	17	18,5	19,5	21	14
	12	13,2	14,0	15,2	10,4	11,2	12,4	13,2	14	9,6	12,8	14,4	15,2	16	10,8	13,6	14,8	15,6	16,8	11,2
40 S4	17,5	19	20	22	14,5	16,5	18	19	20,5	13	19	20,5	21,5	23,5	15	19,5	21	22	24,5	15,5
	14,0	15,2	16,0	17,6	11,6	13,2	14,4	15,2	16,4	10,4	15,2	16,4	17,2	18,8	12	15,6	16,8	17,6	19,6	12,4
40 M5	20	22	23	25	16	18,5	20,5	21,5	23	15	21,5	23,5	25	27	17	22	24,5	26	27,5	17,5
	16	17,6	18,4	20	12,8	14,8	16,4	17,2	18,4	12,0	17,2	18,8	20	21,6	13,6	17,6	19,6	20,8	22	14
40 L7	22	24,5	25,5	28	17,5	20,5	23	24	25	15,5	24	26	27,5	30	18,5	24,5	27	28,5	31	19,5
	17,6	19,6	20,4	22,4	14	16,4	18,4	19,2	20	12,4	19,2	20,8	22	24	14,8	19,6	21,6	22,8	24,8	15,6

Efficiencies 50 Hz (— P.F. : 0.8) (..... P.F. : 1)

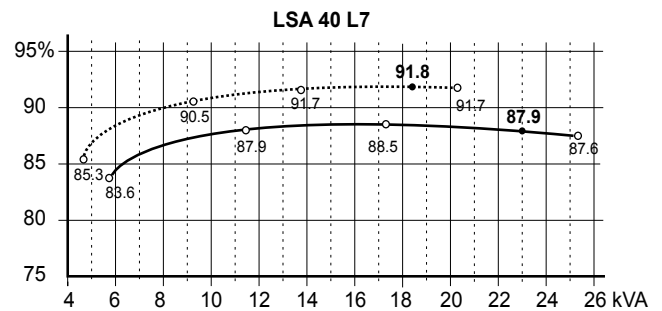
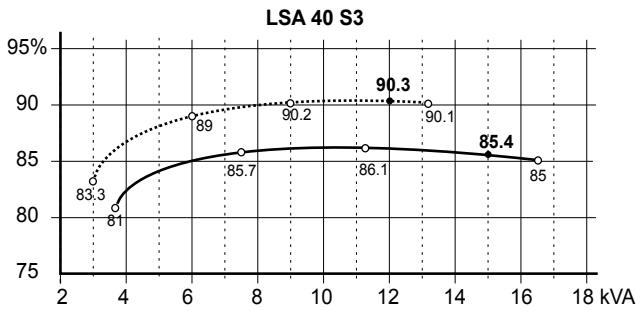
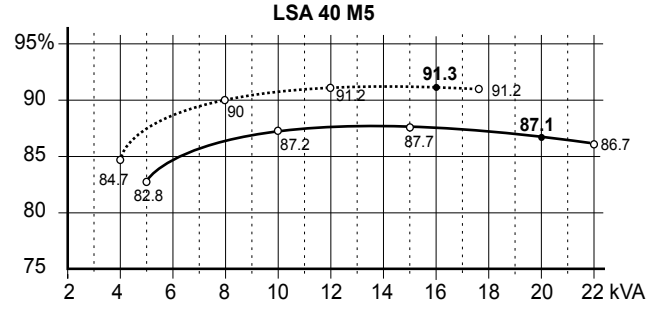
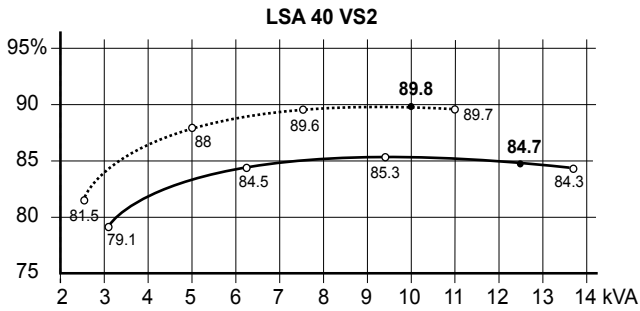
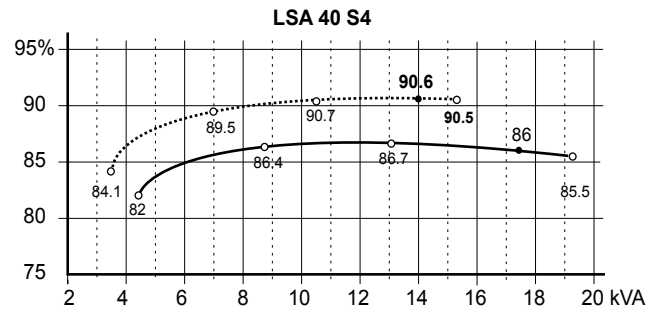
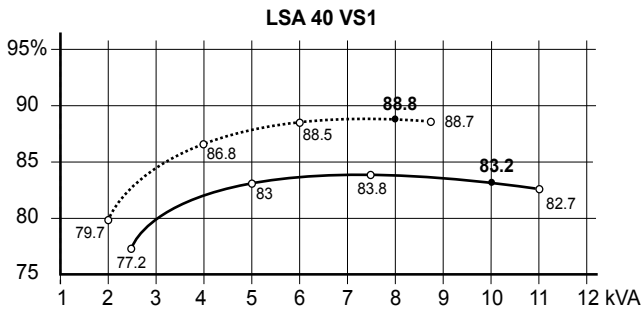

Reactances (%). Time constants (ms) - Class H/400 V

		VS1	VS2	S3	S4	M5	L7
Kcc	Short-circuit ratio	0,72	0,69	0,62	0,62	0,63	0,63
Xd	Direct-axis synchro. reactance unsaturated	167	174	190	195	193	192
Xq	Quadrature-axis synchro. reactance unsaturated	100	104	114	117	116	115
T'do	No-load transient time constant	780	858	909	953	1006	1072
X'd	Direct-axis transient reactance saturated	17,2	16,3	16,8	16,4	15,4	14,4
T'd	Short-circuit transient time constant	74	74	74	74	74	74
X''d	Direct-axis subtransient reactance saturated	8,6	8,1	8,4	8,2	7,7	7,2
T''d	Subtransient time constant	7	7	7	7	7	7
X''q	Quadrature-axis subtransient reactance saturated	16,1	15,9	16,8	16,8	16,2	15,6
Xo	Zero sequence reactance unsaturated	0,1	0,1	0,1	0,1	0,1	0,1
X2	Negative sequence reactance saturated	12,4	12,0	12,7	12,6	12,0	11,4
Ta	Armature time constant	11	11	11	11	11	11

Other class H/400 V data

io (A)	No-load excitation current (SHUNT/AREP)	0,8	0,8	0,8	0,8	0,8	0,7
ic (A)	On-load excitation current (SHUNT/AREP)	2,0	2	2,1	2,1	2	2
uc (V)	On-load excitation voltage (SHUNT/AREP)	25	25	26	26	24	24
ms	Response time ($\Delta U = 20\%$ transient)	<300ms	<300ms	<300ms	<300ms	<300ms	<300ms
kVA	Start ($\Delta U = 20\%$ cont. or ($\Delta U = 30\%$ trans.) SHUNT	25	29	36	44	52	62
kVA	Start ($\Delta U = 20\%$ cont. or ($\Delta U = 30\%$ trans.) AREP	25	29	36	44	52	62
%	Transient ΔU (on-load 4/4) SHUNT - P.F.: 0.8 _{LAG}	< 16%	< 15.2%	< 14.7%	< 13.9%	< 13.2%	< 13.2%
%	Transient ΔU (on-load 4/4) AREP - P.F.: 0.8 _{LAG}	< 16%	< 15.2%	< 14.7%	< 13.9%	< 13.2%	< 13.2%
W	No-load losses	460	520	550	600	660	730
W	Heat dissipation	1610	1790	2040	2270	2360	2510

Transient voltage variation 400 V - 50 Hz

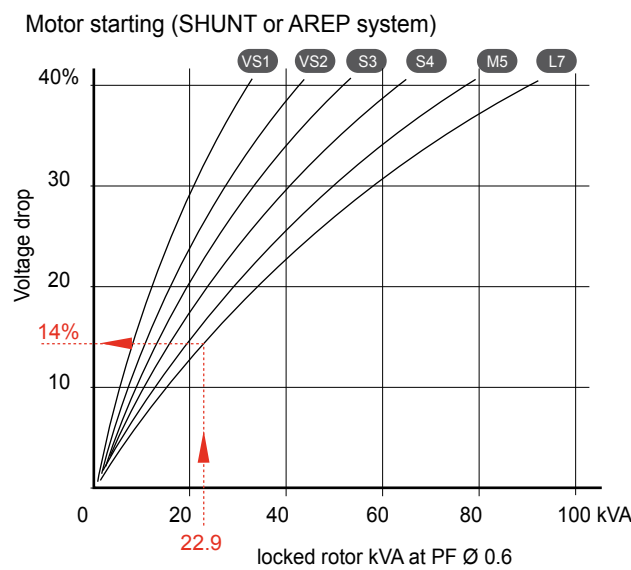
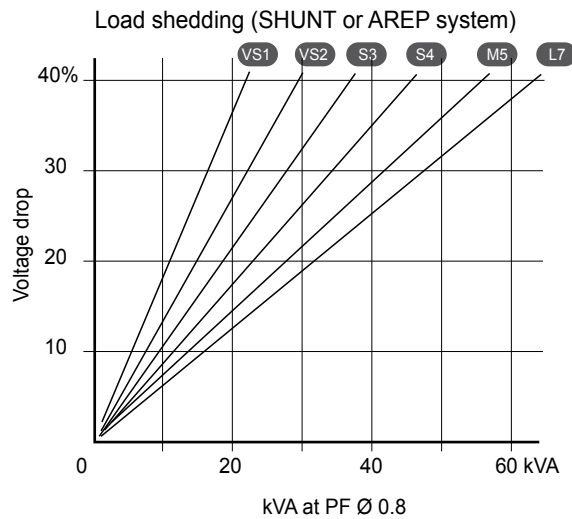
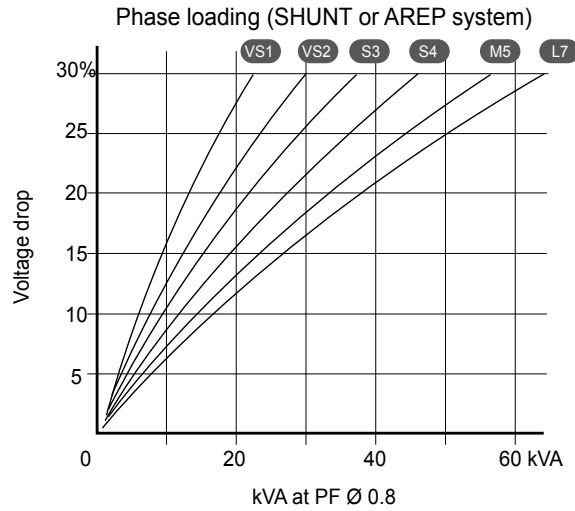

1) For a PF with a ϕ other than 0.6, multiply the kVA by $K = \sin \phi / 0.6$

Example of calculation for a PF with a ϕ other than 0.6: motor starting kVA calculated at PF ϕ 0.4 = 20 kVA

► $\sin \phi$ 0.4 = 0.9165 ► $K = 1.145$ ► corrected kVA = 22.9 kVA ► Corresponding voltage drop for L7 = 14%.

2) For a voltage U other than 400 V (Y), 230 V (Δ) at 50 Hz, multiply the kVA by $(400/U)^2$ or $(230/U)^2$.

Efficiencies 60 Hz (— P.F. : 0.8) (..... P.F. : 1)

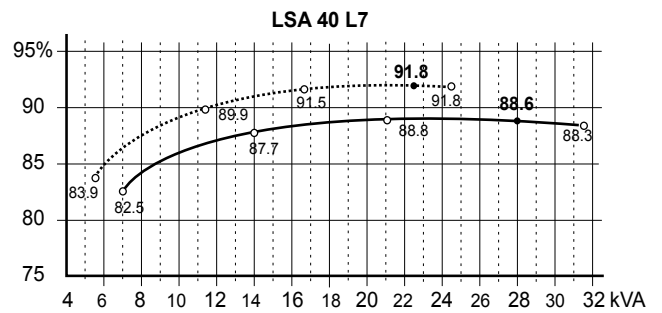
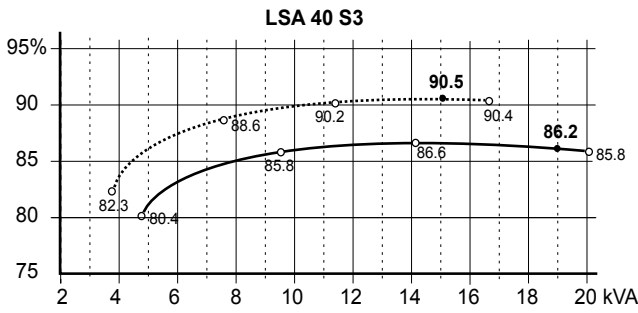
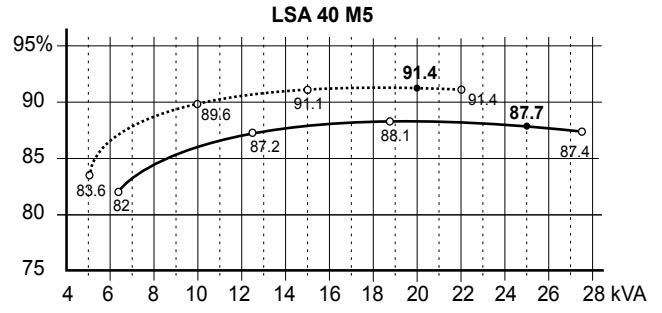
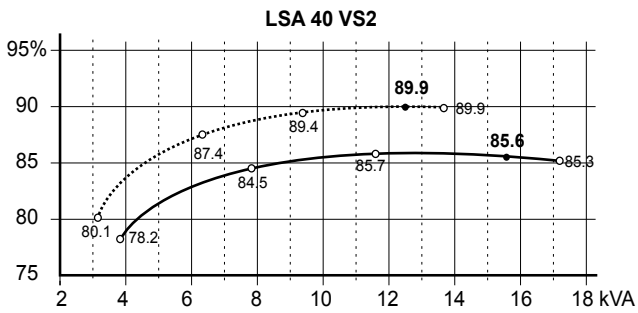
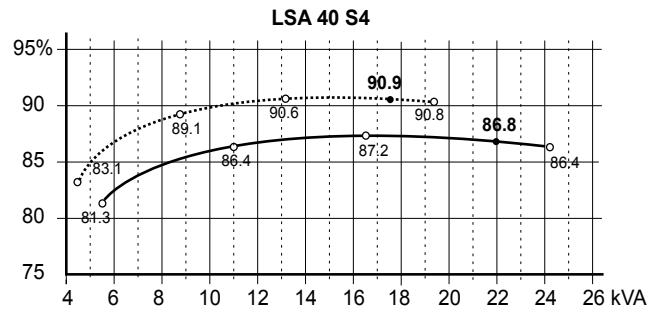
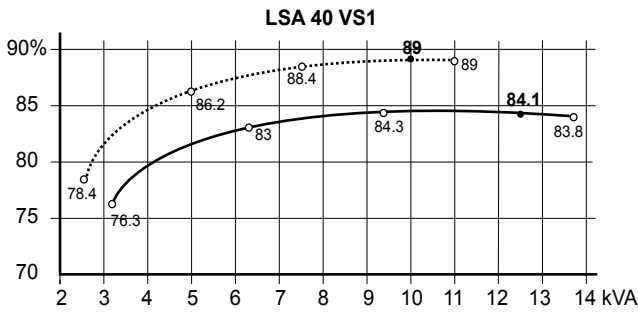

Reactances (%). Time constants (ms) - Class H/480 V

	VS1	VS2	S3	S4	M5	L7
Kcc Short-circuit ratio	0,69	0,67	0,59	0,59	0,61	0,62
Xd Direct-axis synchro. reactance unsaturated	174	180	201	204	201	195
Xq Quadrature-axis synchro. reactance unsaturated	104	108	120	122	121	117
T'do No-load transient time constant	780	858	909	953	1006	1072
X'd Direct-axis transient reactance saturated	17,9	16,8	17,8	17,2	16,1	14,6
T'd Short-circuit transient time constant	74	74	74	74	74	74
X''d Direct-axis subtransient reactance saturated	8,9	8,4	8,9	8,6	8,0	7,3
T''d Subtransient time constant	7	7	7	7	7	7
X''q Quadrature-axis subtransient reactance saturated	16,7	16,4	17,8	17,6	16,9	15,9
Xo Zero sequence reactance unsaturated	0,1	0,1	0,1	0,1	0,1	0,1
X2 Negative sequence reactance saturated	12,9	12,4	13,4	13,1	12,5	11,6
Ta Armature time constant	11	11	11	11	11	11

Other class H/480 V data

io (A) No-load excitation current (SHUNT/AREP)	0,8	0,8	0,8	0,8	0,8	0,7
ic (A) On-load excitation current (SHUNT/AREP)	2,0	2,0	2,2	2,2	2,0	1,9
uc (V) On-load excitation voltage (SHUNT/AREP)	25	25	26	26	25	24
ms Response time ($\Delta U = 20\%$ transient)	<300ms	<300ms	<300ms	<300ms	<300ms	<300ms
kVA Start ($\Delta U = 20\%$ cont. or ($\Delta U = 30\%$ trans.) SHUNT	30	35	43	53	62	74
kVA Start ($\Delta U = 20\%$ cont. or ($\Delta U = 30\%$ trans.) AREP	30	35	43	53	62	74
% Transient ΔU (on-load 4/4) SHUNT - P.F.: 0.8 _{LAG}	< 16.4%	< 15.4%	< 15.2%	< 14.3%	< 13.5%	< 13.3%
% Transient ΔU (on-load 4/4) AREP - P.F.: 0.8 _{LAG}	< 16.4%	< 15.4%	< 15.2%	< 14.3%	< 13.5%	< 13.3%
W No-load losses	650	730	770	840	920	1020
W Heat dissipation	1880	2080	2420	2670	2780	2870

Transient voltage variation 480 V - 60 Hz

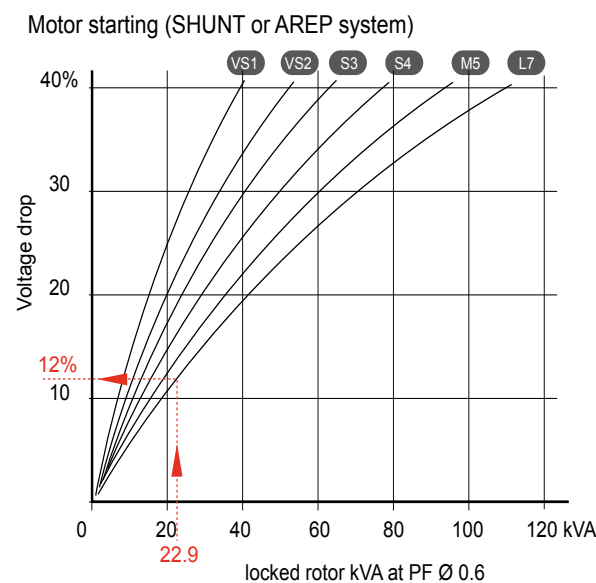
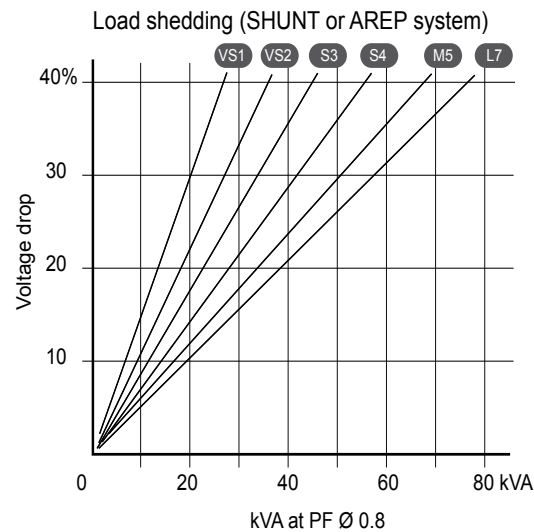
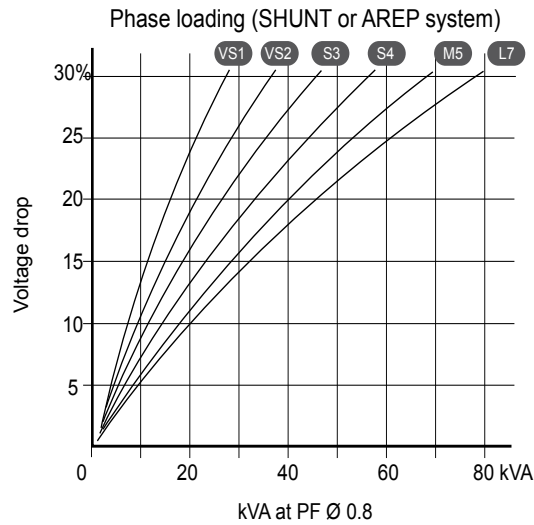

1) For a PF with a $\cos \phi$ other than 0.6, multiply the kVA by $K = \sin \phi / 0.8$

Example of calculation for a PF with a $\cos \phi$ other than 0.6: motor starting kVA calculated at PF $\cos \phi = 0.4 = 20$ kVA

▶ $\sin \phi = 0.4 = 0.9165$ ▶ $K = 1.145$ ▶ corrected kVA = 22.9 kVA ▶ Corresponding voltage drop for L12 = 10%.

2) For a voltage U other than 480 V (Y), 277 V (Δ), 240 V (YY) at 60 Hz, multiply the kVA by $(480/U)^2$ or $(277/U)^2$ or $(240/U)^2$.

3-phase short-circuit curves at no load and rated speed (star connection Y)

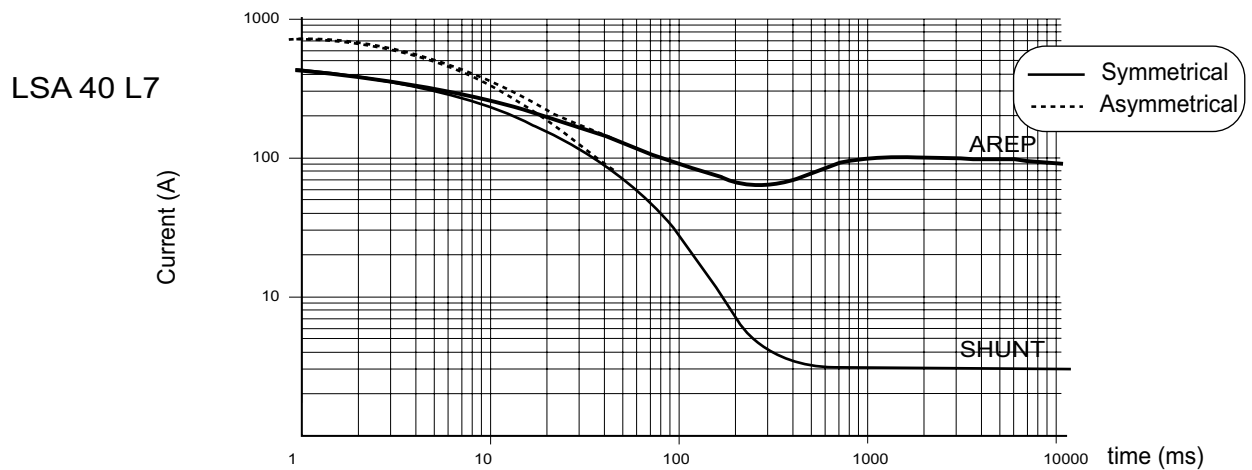
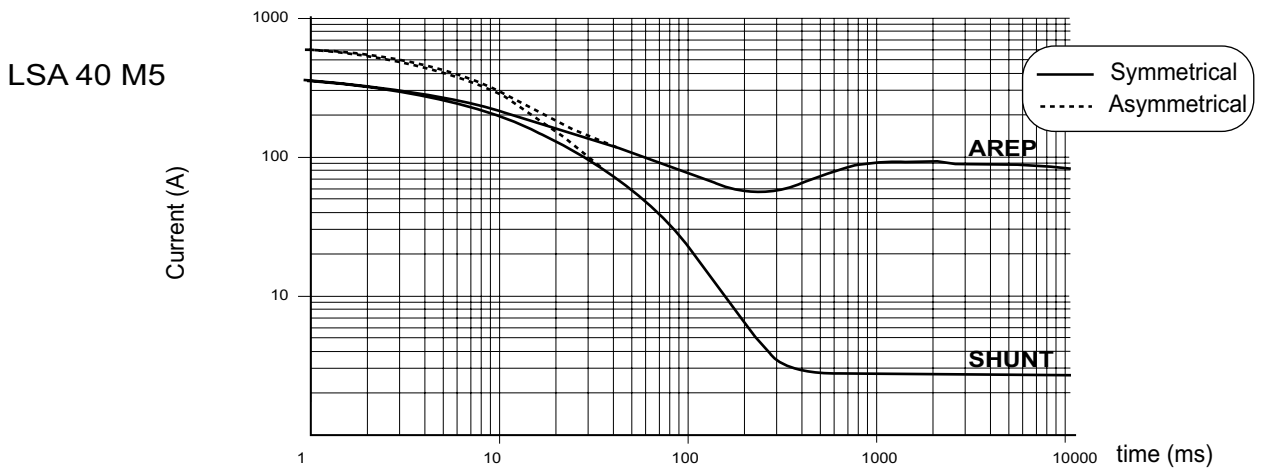
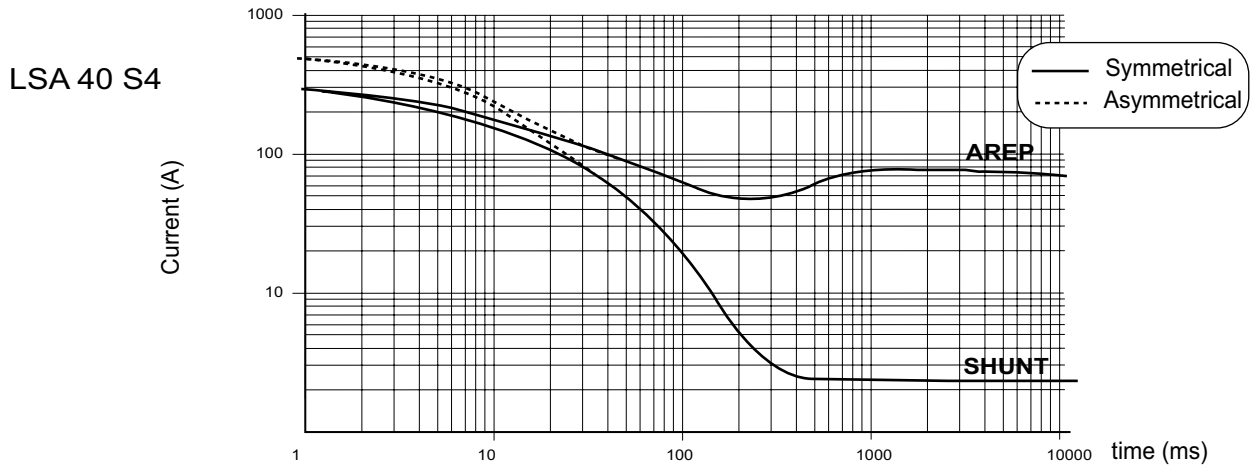

Influence due to connection

Curves shown are for star (Y) connection.

For other connections, use the following multiplication factors:

- Series delta : Current value x 1.732
- Parallel star : Current value x 2

3-phase short-circuit curves at no load and rated speed (star connection Y)

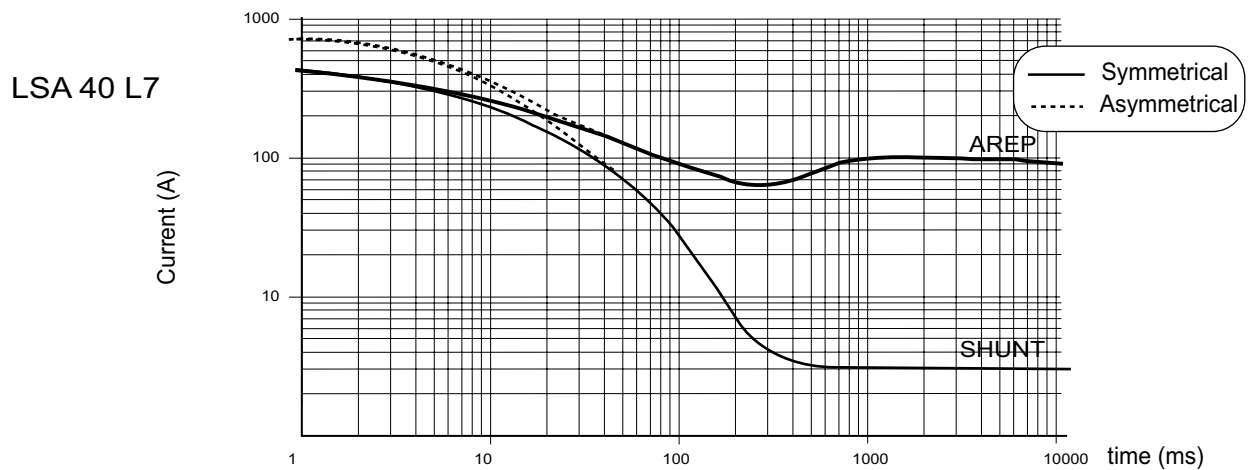
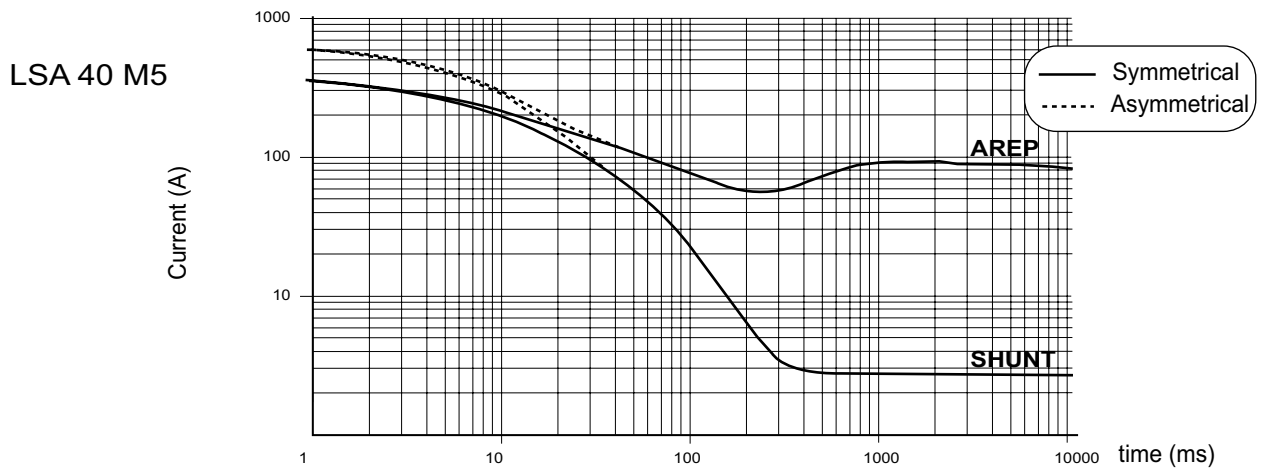
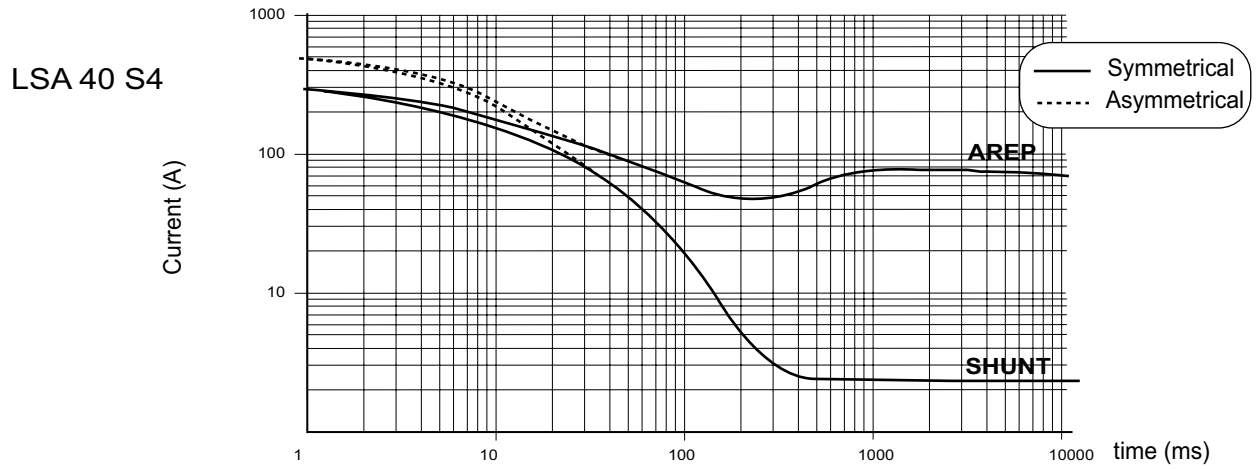

Influence due to short-circuit

Curves are based on a three-phase short-circuit.

For other types of short-circuit, use the following multiplication factors:

	3-phase	2-phase L/L	1-phase L/N
Instantaneous (max.)	1	0.87	1.3
Continuous	1	1.5	2.2
Maximum duration (AREP/PMG)		1.5	

Single bearing dimensions

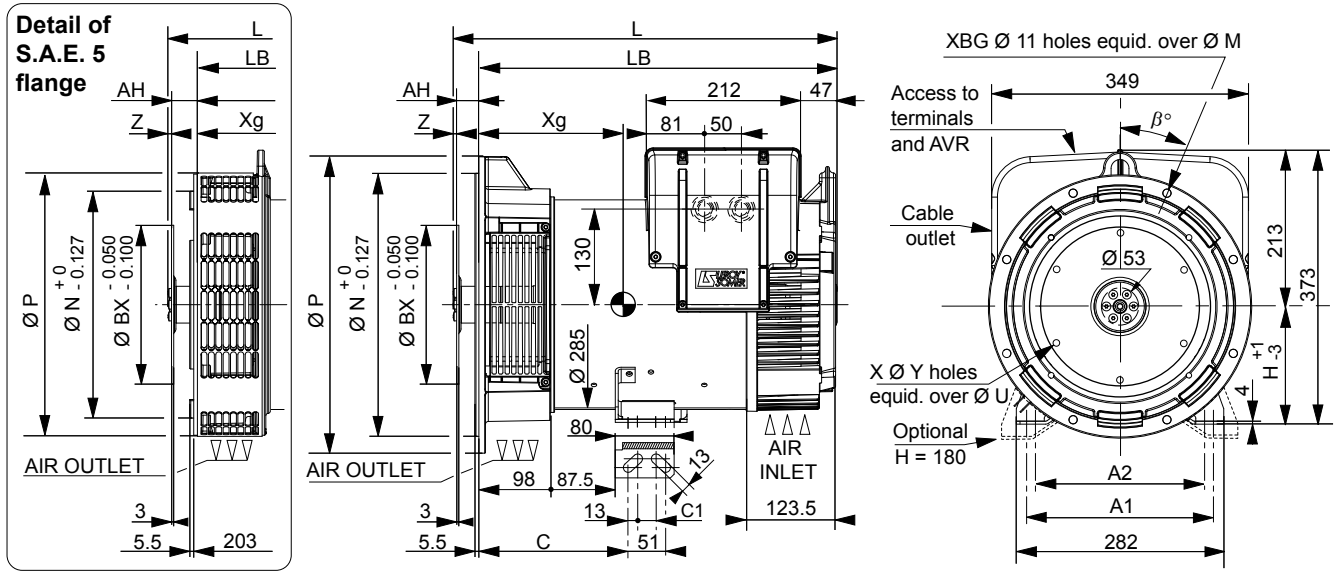

Frame dimensions (mm)				
	L	LB	Xg	Weight (kg)
LSA 40 VS1	467	405	186	73
LSA 40 VS2	467	405	196	80
LSA 40 S3	497	435	204	87
LSA 40 S4	497	435	221	92
LSA 40 M5	517	455	221	102
LSA 40 L7	547	485	236	112

	Standard	Optional
Shaft height		
H	160	180
Feet length		
C	203	238
C1	25	22
A1	254	279
A2	230	-

Coupling				
	Flange 3	4	5	
Flex plate				
11 1/2	x	-	-	
10	x	x	-	
8	x	x	-	
7 1/2	-	x	x	
6 1/2	-	x	x	

Flange dimensions (mm)					
S.A.E.	P	N	M	XBG	β°
5	358	314.32	333.38	8	22°30'
4	408	361.95	381	12	15°
3	460	409.58	428.62	12	15°

Flex plate dimensions (mm)						
S.A.E.	BX	U	X	Y	AH	Z
11 1/2	352.42	333.38	8	11	39.6	0
10	314.32	295.28	8	11	53.8	0
8	263.52	244.48	6	11	62	0
7 1/2	241.3	222.25	8	9	30.2	4.5
6 1/2	215.9	200.02	6	9	30.2	4.5

Torsional analysis data

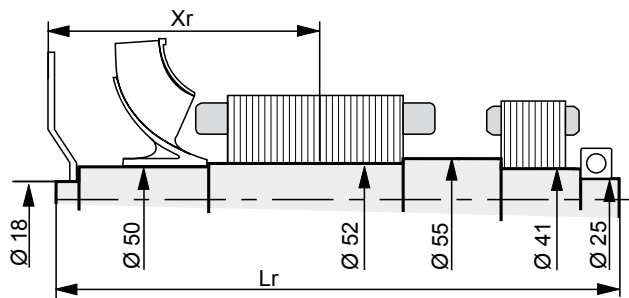

Centre of gravity: Xr (mm), Rotor length: Lr (mm), Weight: M (kg), Moment of inertia: J (kgm²): (4J = MD²)																				
TYPE	S.A.E. 6 1/2				S.A.E. 7 1/2				S.A.E. 8				S.A.E. 10				S.A.E. 11 1/2			
	Xr	Lr	M	J	Xr	Lr	M	J	Xr	Lr	M	J	Xr	Lr	M	J	Xr	Lr	M	J
LSA 40 VS1	211.7	428	25.54	0.0779	211.7	428	25.7	0.0802	243.5	428	26	0.0847	238.3	428	26.5	0.0964	221.1	428	27	0.1080
LSA 40 VS2	221.7	428	27.95	0.0867	221.7	428	28.11	0.0890	253.5	428	28.41	0.0935	248.3	428	28.91	0.1052	231.1	428	29.41	0.1168
LSA 40 S3	229.2	458	30.32	0.0936	229.2	458	30.48	0.0959	261	458	30.78	0.1004	255.8	458	31.28	0.1121	238.6	458	31.78	0.1237
LSA 40 S4	236.7	458	32.23	0.1004	236.7	458	32.39	0.1027	268.5	458	32.69	0.1072	263.3	458	33.19	0.1189	246.1	458	33.69	0.1305
LSA 40 M5	246.7	478	35.26	0.1102	246.7	478	35.42	0.1125	278.5	478	35.72	0.1170	273.3	478	36.22	0.1287	256.1	478	36.72	0.1403
LSA 40 L7	261.7	508	39.47	0.1237	261.7	508	39.63	0.1260	293.5	508	39.93	0.1305	288.3	508	40.43	0.1422	271.1	508	40.93	0.1538

Two bearing dimensions

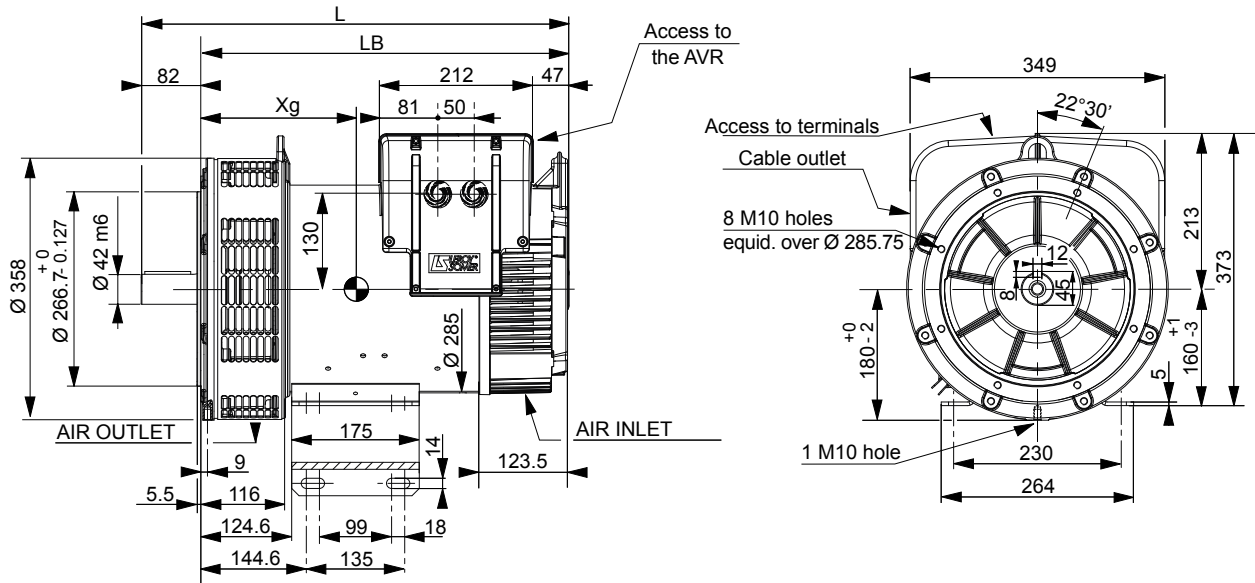

Dimensions (mm)

TYPE	L	LB	Xg	Weight (kg)
LSA 40 VS1	505	423	198	82
LSA 40 VS2	505	423	208	89
LSA 40 S3	535	453	216	96
LSA 40 S4	535	453	233	101
LSA 40 M5	555	473	233	109
LSA 40 L7	585	503	248	121

Torsional analysis data

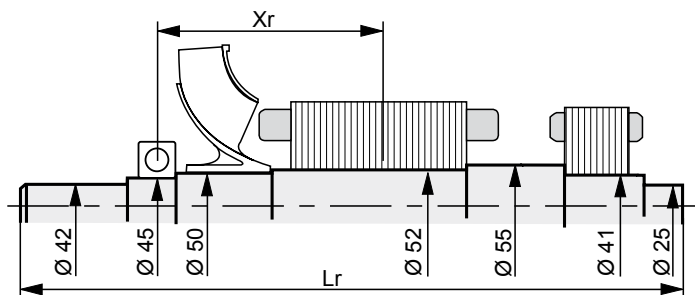

Centre of gravity: Xr (mm), Rotor length: Lr (mm), Weight: M (kg), Moment of inertia: J (kgm²): (4J = MD²)

TYPE	Xr	Lr	M	J
LSA 40 VS1	176.5	450.2	25.38	0.0731
LSA 40 VS2	186.5	450.2	27.79	0.0819
LSA 40 S3	194	480.2	30.16	0.0888
LSA 40 S4	201.5	480.2	32.07	0.0956
LSA 40 M5	211.5	500.2	35.10	0.1054
LSA 40 L7	226.5	530.2	39.31	0.1189

International network

www.leroy-somer.com

ALGERIA

LEROY-SOMER International Division

AUSTRALIA

LEROY-SOMER PTY LTD

AUSTRIA

LEROY-SOMER ELEKTROMOTOREN

BELGIUM

LEROY-SOMER BELGIUM

BRAZIL

LEROY-SOMER DIVISION
EMERSON ELECTRIC DO BRASIL Ltda.

CANADA

LEROY-SOMER / EMC

CHINA

LEROY-SOMER Division

CROATIA

Emerson Network Power Ltd

CZECH REPUBLIC

M.L.S. HOLICE S.R.O.

DENMARK

LEROY-SOMER DENMARK A/S

EGYPT

MOTEURS LEROY-SOMER

FRANCE

MOTEURS LEROY-SOMER

GERMANY

LEROY-SOMER Marbaise GmbH

GREECE

LEROY-SOMER Ltd

HUNGARY

LEROY-SOMER I.M.I.

INDIA

LEROY-SOMER C/O EMERSON ELECTRIC CO.

ITALIA

LEROY-SOMER

JAPAN

LEROY-SOMER DIVISION
EMERSON Japan Ltd.

KOREA

EMERSON ELECTRIC KOREA

MOROCCO

CARREFOUR INDUSTRIEL ET TECHNOLOGIQUE

NETHERLANDS

LEROY-SOMER NEDERLAND B.V

POLAND

FZN MARBAISE LS

ROMANIA

LEROY-SOMER REPRESENTATIVE OFFICE

RUSSIA

LEROY-SOMER DIVISION

SAUDI ARABIA

ABUNAYYAN TRADING CORPORATION

SINGAPORE

LEROY-SOMER SOUTHEAST ASIA Pte Ltd

SOUTH AFRICA

LEROY-SOMER PTY LTD

SPAIN

LEROY-SOMER IBERICA S.A.

SWEDEN

LEROY-SOMER NORDEN AB

SWITZERLAND

LEROY-SOMER SA

TAIWAN

LEROY-SOMER LIAISON OFFICE

THAILAND

LEROY-SOMER THAILAND

TUNISIA

ULYSSE SPARE PARTS

TURKEY

ELEKTROMEKANIK SISTEMLER

U.A.E.

LEROY-SOMER DIVISION
EMERSON FZE

UNITED KINGDOM

LEROY-SOMER LTD

USA

LEROY-SOMER POWER AND DRIVES

VENEZUELA

LEROY SOMER C/O EMERSON ELECTRIC CA



**LEROY
SOMER**

EMERSON
Industrial Automation